

ECU-02 Ver2.1

Automatic Engine Control Unit Operators Manual



固也泰電子工業有限公司
KUTAI ELECTRONICS INDUSTRY CO., LTD.



Headquarters : No.3, Lane 201, Chien Fu ST., Chyan Jenn Dist., Kaohsiung, TAIWAN

Tel : + 886-7-8121771

Fax : + 886-7-8121775

URL : <http://www.kutai.com.tw>

TABLE OF CONTENTS

<i>Section</i>	<i>Page</i>
INTRODUCTION	3
1. FRONT PANEL LAYOUT	3
1.1 Front Panel Layout.....	3
1.2 Rear Panel Layout	3
2. OPERATION	4
2.1 Control.....	4
2.2 Auto Mode Of Operation	4
2.3 Manual Mode Of Operation.....	5
2.4 Off Mode Of Operation.....	6
3. PROGRAMMING INSTRUCTIONS	6
3.1 Battery Voltage.....	6
3.2 Programming.....	6
3.3 Programming The Hour Meter	7
3.4 Setting Up The Magnetic Pick-Up.....	7
3.5 Volts And Amps Readout Programming	7
3.6 Notice For The ECU-02 Is Working Over 400 Volts (Line 3)	7
3.7 Generator Overload Protect Function	8
3.8 User Defined Inputs Alarm 1 To 4.....	8
3.9 Information On The Service Interval Display	9
3.10 Display Mode Setting	9
3.11 Engine Test And Setup For Start / Stop --- Led Lamp Test.....	10
3.12 Line By Line Programming Table.....	10
4. PROTECTIONS AND ALARMS	12
4.1 Information On The Display	12
4.2 Alarms	12
4.3 Engine Stop / Shutdowns.....	12
4.4 Alarms Table	12
5. INSTALLATION INSTRUCTIONS	13
5.1 Cooling	13
5.2 Panel Cut-Out (All Dimensions In mm.).....	13
5.3 Unit Dimensions (All Dimensions In mm.).....	13
6. ELECTRICAL CONNECTIONS	14
6.1 Connection Details On The ECU-02	14
6.2 Specification	15
7. FAULT FINDING	15
8. TYPICAL WIRING DIAGRAM IF ECU RELAY BOARD IS NOT USED	16

INTRODUCTION

The ECU-02 Generator Control module is used to start and stop a generator-set automatically. In addition to its automatic start-stop function, the module monitors any problems related to engine/generator performance and gives the operator digital readouts for all working parameters. The module will, by design, stop the engine and diagnose engine / generator failures on a large, easy-to-read 4 digit/7-segment front display panel with flashing, light emitting diodes (LED's). Remote starting is accomplished via standard, two-wire

signals from any Automatic Transfer Switch or remote switch. Model ECU-02 also includes a generator overload protection.

The module also features easily adjustable operational sequences, timers and alarm trips. These customizations can be programmed easily by the customer via the rear and front display panel. These are the buttons (PROM on rear, + and - on the front). There is no need for a PC connection and programming software. Any and all changes can be made in the field.

1. FRONT PANEL LAYOUT

1.1 Front Panel Layout

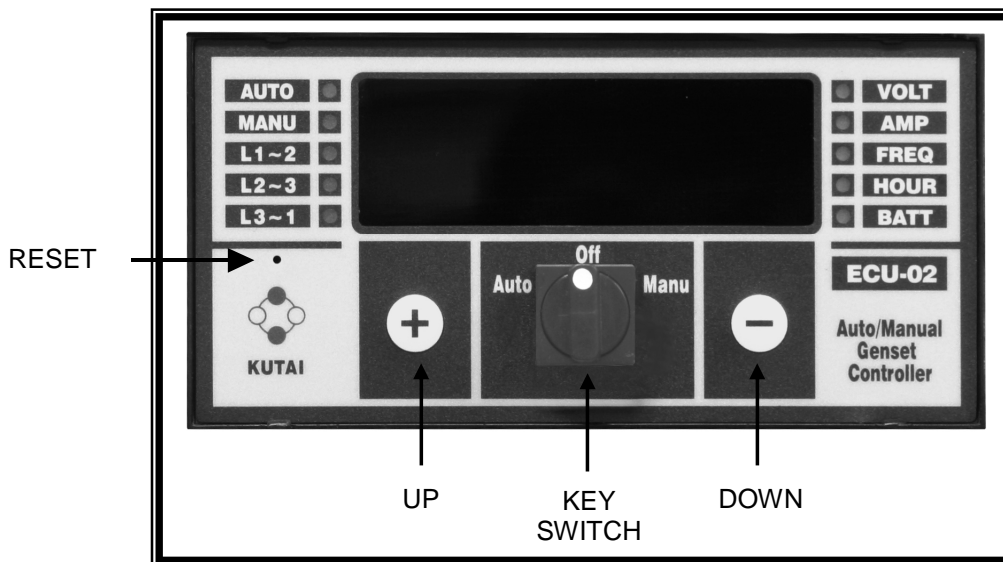

1.2 Rear Panel Layout

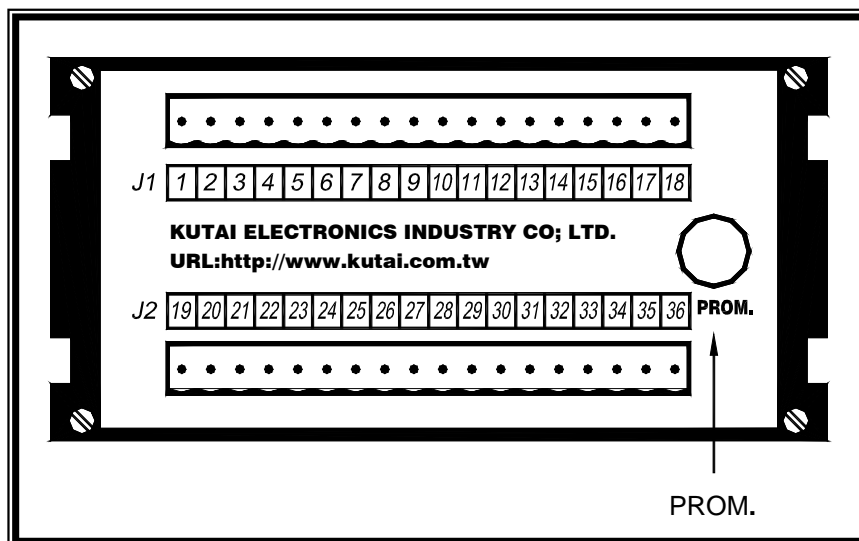

2. OPERATION

2.1 Control

The ECU-02 is controlled by using the front display panel Selector Switch (See 1.1). There are only three positions from which to choose : AUTO, OFF and MANUAL. The Selector Switch is the only control you need to operate the generator.

The Selector Switch is framed by two small push-buttons, – (DOWN)/ + (UP) (See 1.1). These buttons access more complex information, such as Voltage VOLT and Amperage AMP on each phase L1-2, L2-3, L3-1, FREQ in Hertz, HOUR hour meter, BATT battery voltage, and remaining time until next service. These functions are described in greater detail in section 3.9 ~ 3.11.

2.2 Auto Mode Of Operation

With the Selector Switch on the “ Automatic ” position, the ECU-02 controls all the functions of the generator-set. The two Remote Start Inputs (see 1.2 terminals 15 and 16) on the ECU-02 are monitored constantly. Once the start condition is signaled by an Automatic Transfer Switch or a remote start switch, the ECU-02 commences the start sequence. The generator automatically is then placed on load.

AUTO SEQUENCE :

The flashing AUTO LED on the front panel (see 1.1) indicates, at a glance, that the generator-set is on stand-by and ready to start. When a Remote Start signal is given by the ATS, the AUTO LED stops flashing, indicating that the engine is on start countdown and will start.

If the engine needs Pre-heat and this option is selected, the ECU-02 starts pre-heating the engine, and the corresponding relay output is energized. The front display will read “ Ph.XX ”, and the Pre-heat timer will count down the seconds on the front panel. Setting 0 (NO Pre-heat) on the programming sequence will set an automatic 5 second engine start delay before starting the engine. (The display will indicate “ 05 ”) For additional instruction on programming. (See 3.12)

NOTE

If the Remote Start signal is removed during the Pre-heat Delay, the unit will return to a stand-by state after the Stop period.

After the above start delays, the Fuel Solenoid and Starter Motor are energized. The display will indicate “ St.XX ”, and the Starter cranking timer will count down on the front display panel.

The engine cranks for a pre-programmed time period. Should the engine fail to start during these first cranking attempts, the starter motor disengages, and the engine goes into pre-heat again. Should this sequence go beyond the set number of start attempts, starting will be terminated, and the start fault alarm will be displayed by a flashing “ AL.00 ” on the front panel.

After the engine starts, the starter motor is automatically disengaged by sensing 1, or as may as 3, different signals from the engine. These signals are : (1) a pre-set frequency (20% of rated frequency); (2) output voltage from the generator, and (3) oil pressure switch signal from the engine and/or the signal from the Magnetic Pick-Up. Any one or up to all three signals can be use to disengage the starter motor.

NOTE

If you program the oil pressure switch to disconnect the starter, you may get a false oil pressure reading, giving you premature starter disconnect and tricking the ECU to believe the engine is running. (For example: when testing the engine with repeated starts; when the engine is cool and the crankcase oil is thick; and certain types of engines that build UP oil pressure quickly before engine start). If this is the case, remember that you have other programmable choices for disengaging the starter that are equally as effective.

After the starter disengages and the engine is running normally, a grace period is activated. This grace period allows oil pressure, engine speed, voltage and any other delayed Auxiliary inputs to be stabilized, before monitoring and triggering any faults (if any).

After the engine is running, the Engine Warm UP timer, if selected, is initiated. The Warm UP timer allows the engine to warm up and stabilize before accepting any loads. A signal is given to a load transfer contactor to activate and take up the load. (BE AWARE that some generators sets have no Load Contactor)

NOTE

A load transfer output will not be initiated until the Oil Pressure, Engine Speed and alternating voltages have risen and are all normal.

With the return of normal power, the ATS removes the Remote Start signal. The load transfer contactor is the first to be de-energized, removing the load and initiating the engine Cool Down phase (engine with no load). The display will indicate " CL.XX ", and the Cool Down delay timer will count down on the front display panel.

Please be aware if your ATS also includes the above mentioned sequences. If so, then your timed sequences will run concurrently, combining the time programmed. For example, if you have a sixty second cool-down on an ATS and sixty second cool-down programmed on the ECU-02, your total cool-down will be 120 seconds.

To avoid this redundancy, set the ECU-02 timing delays (i.e. warm-up, cool-down) to 0 if your ATS includes these functions.

After the Cool-Down times out, the Fuel Solenoid is (de-energized or energized as the case may be) bringing the generator to a stop. The front display will indicate " SP.XX ", and the Stop delay timer will count down on the front panel. The ECU will reset, and the remote start LED will start flashing, indicating the generator is on standby and ready to start.

Should the Remote start signal be re-activated during the cooling down period, the set will immediately return to load.

2.3 Manual Mode Of Operation

Manual operation is conducted by turning the Selector Switch to Manual on the front display panel (See 1.1) The start sequence is the same as in the AUTO MODE sequence of operation (See 2.2 above). Turning the Selector Switch to OFF stops the engine after cool-down. In Manual the MANU LED is illuminated.

NOTE

In manual mode of operation, the ATS will not operate the ECU-02. Remote start is disabled.

2.4 Off Mode Of Operation

The OFF position places the module into its Stop or Reset mode. This will clear any alarm conditions for which the triggering criteria have been removed.

If the engine is running and this position is selected, the module will automatically shut down the generator. The fuel supply will be removed and engine will be brought to a standstill. Should a remote start signal be present while operating in this mode, a remote start will not occur.

3. PROGRAMMING INSTRUCTIONS

NOTE

Further programming and configuration must be made with the ECU-02 installed and connected to the battery.

3.1 Battery Voltage

The ECU-02 engine control unit automatically adjusts itself to DC12 or DC24 volts systems. When cranking, voltages drop sometimes to levels (under 6Vdc) that may render the ECU ineffective, due to a low or defective battery. Install new batteries or fix the starter. If the unit freezes because of low cranking voltage, it may be reset by: disconnecting B- from the battery for 4 seconds; or, you can simply push the reset button behind the front panel with a thin isolation tool for 1 second. (See 1.1 for front panel layout)

3.2 Programming

With the Selector Switch on OFF, push the button " PROM " on the rear panel of ECU-02 for 4 seconds. The word " Ver 2.1 " will appear on the front display for 2 seconds. This number indicates the version of the software. After that, the word " Pro. " will appear on the front panel for 4 seconds.

You are now ready to start a line by line programming sequence. To advance to the next line, push the PROM button on the back panel. (See 1.2)

Use the UP (+) and DOWN (-) buttons, to change each line's programming parameters.

Always push the "PROM" button to advance to next programming line or until the word "END" appears on the screen. To immediately end the programming mode, you can simply push the "PROM" button for 4 seconds at any time. The word END on the front display panel indicates a return to previous settings.

Should you make an error or desire to return to factory settings, stay in "Pro." mode and simultaneously press all 3 buttons : UP (+), DOWN (-) and PROM for 4 seconds. The ECU-02 will now automatically program itself to factory settings and the word "Au.Po" will appear on the display. (See table 3.12 for ECU-02 factory settings.)

3.3 Programming The Hour Meter

Turn the Selector Switch to the OFF position. Push the "PROM" button on the rear panel until the word "Pro." appears on the screen. Push the "UP(+)" key one time quickly before the word "Pro." disappears. The front display will read "Ch.Hr" indicating the operating hours of the gen-set. To reconcile the ECU-02 with the gen-set's hours (For example, to set the ECU-02 at 200 hours to match a gen-set with 200 previous operating hours), push the UP (+) and DOWN (-) buttons to the number of hours desired.

After resetting the hour meter, simply push the PROM button again. The word "END" on the panel indicates that you are back to normal operating mode.

3.4 Setting Up The Magnetic Pick-Up

Prior to setting the magnetic Pick-Up (Refer table 3.12), you must program lines 12, 13, 14, 15 and 19. Then, start the engine and run it at normal speed (50 or 60 Hz).

Next, set the LED on the front display panel next to FREQ, using the UP (+) and DOWN (-) buttons. When 50 or 60Hz appears on the LED, push the PROM button for one second, and "Pro." will appear. If "FAIL" appears, check the MPU wires and installation and try again.

The ECU-02 is now programmed with an over-speed trip, using the Magnetic Pick-Up that is dependent on the settings for line 14 (105%, 110%, 115% or 120% above rating speed), plus a 20% automatic starter motor disconnect. If any wires on the Magnetic Pick-Up break, the ECU-02 automatically shuts down the engine and shows the flashing alarm signal "AL.02" on the front screen.

3.5 Volts And Amps Readout Programming

Programming lines 2 & 7 are used for fine calibration of the VOLTS & AMPS readout. This option is used only if you have a "calibrated service meter" that you want to synchronize with the readings from the ECU-02.

For example: If the ECU reads 200 Volts but your "Calibrated Mete" reads 205 volts, you can easily add 5 volts to the ECU readout by putting the number 5 on line 2. The next time you start the generator, 5 is automatically added, reading 205 volts on the ECU.

To achieve the same synchronization for amperage AMPS, program line 7 to desired level.

3.6 Notice For The Ecu-02 Is Working Over 400 Volts (Line 3)

It is dangerous to feed high voltage to the ECU Printed Circuit boards. The highest input voltage the ECU-02 can safely read is 400 volts. To work at over 400 volts, we have developed two clear, simple methods :

1. One approach is to use the 1 to 1/2 transformer provided (Part N0. PTU-03). Feed 480 volts into the transformer input and connect the ECU to 1/2 voltage transformer output. Then set programming line 3 to "1." Now, the ECU-02 automatically doubles the input voltage on the display.

2. Another method is to connect the voltage sensing wires to the first Star, using lines T7, T8 & T9 on the generator (See diagram 3.6 below). Next, set programming line 3 to "1." The ECU-02 automatically doubles the input voltage on the display. (Using this method, the Isolating transformers remain 1 to 1)

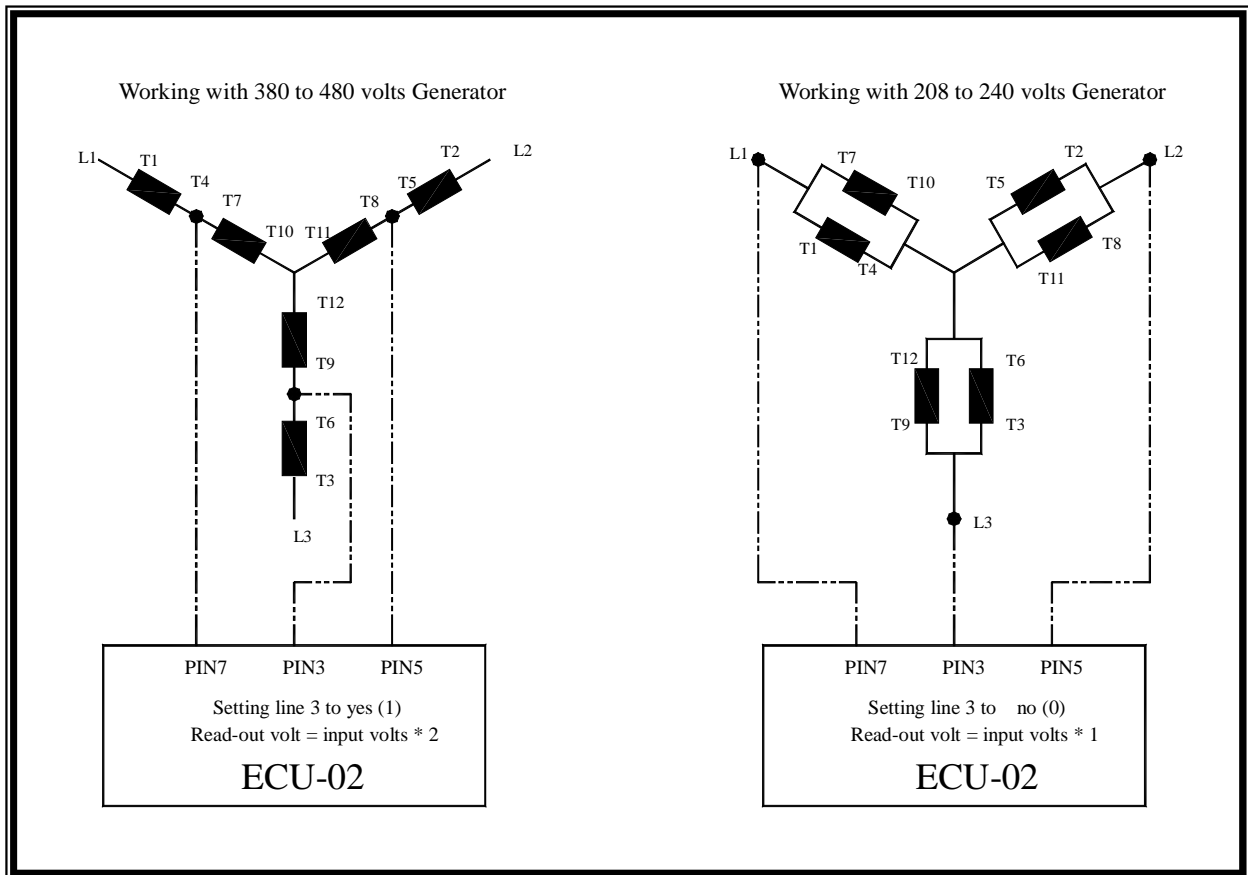

DIAGRAM 3.6

3.7 Generator Overload Protection Function

The function of the Generator overload protector is to STOP the engine if it is overworked by the customer, or if the engine goes over a given " Amps " set point established by the generator

operator. This setting is easily changed, and it has adequate delays to compensate for temporary normal overloads.

Current Transformer Connection

(Correct and ONLY schema for CT connection)

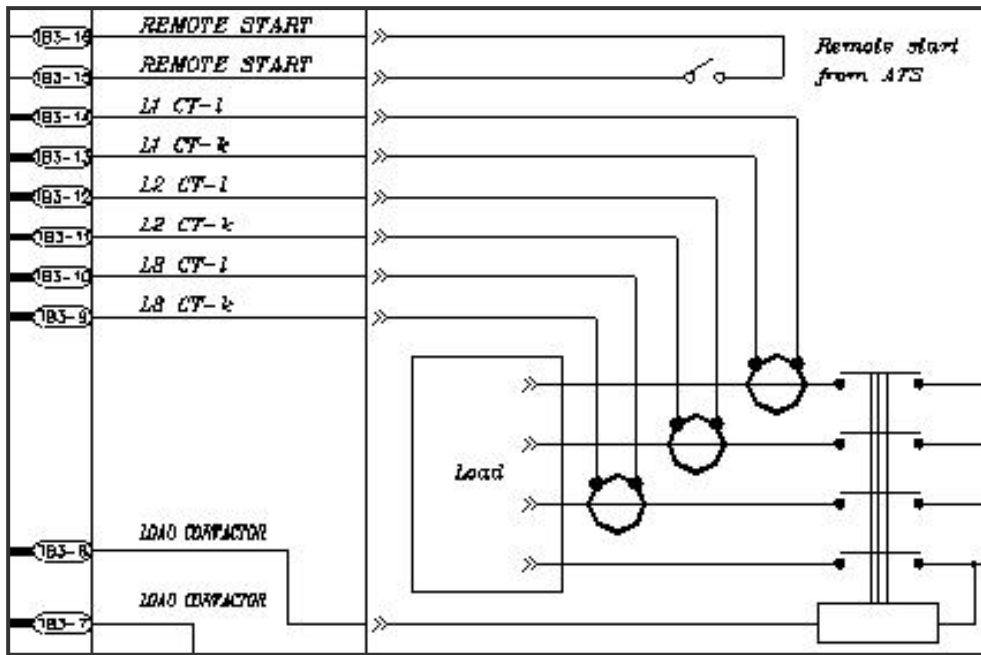

DIAGRAM 3.7

NOTE

Wire each CT individually into the ECU-02.
Do not Daisy Chain or Ground any CT.
(See Diagram 3.7)

NOTE

Never set line 9 to a value larger then the CT (current transformer) correctly inside the generator. For example if we are using 1000/5A CTs, line 9 can not be programmed to a value larger 20 x 50 (1000amps), etc.

When the ECU-02 detects a overload above the set point and this overload continues over the delay time set by line 10, the ECU-02 will shutdown the engine and show " AL.07 " alarm on the front panel. To reprogram a cut-off point, go to line 9 and select a power unit needed. Programming 1 power unit into line 9 is equal to 50 Amps of load (1 power unit = 50 amps). For example, programming line 9 with 20 units represents an overload cut off current of 1000 Amps (50*20=1000)

3.8 User Defined Inputs Alarm 1 To 4

The ECU-02 provides four alarm inputs, which can be defined by the user for any function. These alarms may be defined to provide warnings or shut-downs to the engine. Sensors can be closed or open signals, as defined by the user. To set the alarms, see programming table 3.16, lines 34 to line 42.

All four alarms/sensors are the same except for Alarm 1. This first alarm provides the user a time delay function. You can set the delay response time on alarm 1 from 0 to 99 Seconds, using programming line 36. Alarms 2, 3 and 4 respond immediately, with no delay.

3.9 Information On The Service Interval Display

The engine service reminder is programmed into line 43 and can be set to (0 to 990 hours) hours. To program the hours between services, press the PROM. button and go to line 43. Using the - (DOWN) / + (UP) buttons, select the number of hours desired. Each integer represents ten hours. (For example, setting the number 2 will program a reminder of twenty hours; Setting the number 40 will program a service interval of 400 hours.) If the HOUR LED starts flashing, this is your reminder to give service to the generator set and, afterwards, reset the service meter. Setting the hour to 0 will not provide a maintenance reminder.

To reset the service meter, set the LED to HOUR by pressing the - (DOWN) / + (UP) keys on the front display. Next, push the PROM. button on back panel for 1 second. The ECU-02 is now reset and ready to remind you of your next engine service.

3.10 Display Mode Setting

The ECU-02 provides two display modes. The user has the option to view the entire system's operating parameters (Voltage, Amps, Frequency, Hour meter and DC Voltage) scrolled on the front display or one parameter at a time.

Programming line 44 to 1 allows you to view the voltage, amps and frequency parameters for each phase in rotation automatically. Each parameter will show on the front display for 2 sec and change to the next. In this mode, the ECU-02 allows you to STOP the scrolling to view specific parameter for 30 seconds, by pressing the - (DOWN) or + (UP) buttons. The ECU returns to automated scrolling after 30 seconds.

Programming line 44 to 0 allows you to view the specific parameters without scrolling. You can change the display by simply pressing the - (DOWN) /+ (UP) buttons

3.11 Engine Test And Setup For Start / Stop --- Led Lamp Test

When testing and/or setting up your engine with the ECU-02 for the first time, you can override any engine STOP Commands, thus enabling you to set up engine parameters without the engine stopping every time and interrupting your work. This tool is very helpful when troubleshooting or when adjusting voltages and engine governors on a new engine. Remember; it is very important to preprogram line 24 correctly for Energize to STOP or Energize to START for your engine type, before using this handy tool.

Programming line 45 to 1 allows you to manual start and stop the engine by pressing the (+) key to start and (-) key to STOP. When you are using this tool all the LED's on the panel are lit, so that you may also test all the LED lamps.

When finished utilizing the Engine override function, push the PROM. button one time and the word " END " will appear on the front display. The ECU-02 will return Line 45 to 0 automatically.

3.12 Line By Line Programming Table

ITEM	DESCRIPTION	SETTING	FACTORY SETTING
1	Is this generator operating in 3 phase or 1 phase?	0 → 3 Phase 1 → 1 Phase	0
2	Fine calibration of Voltage read-out (Refer to chapter 3.5)	-50V ~ 50V	0
3	If the ECU is going to work over 400 volt? If Yes, go to chapter 3.6 and read related information	0 → No 1 → Yes (0= volt * 1 1= volt *2)	0
4	Set Under Voltage by setting a number from 16 to 47. (# * 10) For example, the number 18 represent 180 volts, etc	16 ~ 47 (160 ~ 470 V.)	18 (180V)
5	Set Over Voltage by setting a number from 23 to 55. (# * 10) For example, the number 25 represent 250 volts, etc	23 ~ 55 (230 ~ 550 V.)	25 (250V)
6	Time before Generator STOPs, if there is a problem with the generator voltage output	0 ~ 60 sec (0 – No alarms)	15
7	Calibrate the AMPS read-out (Refer to chapter 3.5)	-50A ~ 50A	0
8	Tell ECU-02 what CT (Current Transformer) is going to be installed For example, if installing a 100/5A CT, program the number 5 into ECU-02, etc	1 → 25/5 2 → 50/5 3 → 60/5 4 → 75/5 5 → 100/5 6 → 150/5 7 → 200/5 8 → 250/5 9 → 300/5 10 → 400/5 11 → 500/5 12 → 600/5 13 → 750/5 14 → 800/5 15 → 1000/5 16 → 1200/5 17 → 1500/5 18 → 1600/5 19 → 2000/5 20 → 3000/5	5
9	Overload setting (Refer to chapter 3.7)	1 ~ 60 (50 – 3000A)	2(100A)
10	Time before Generator STOPs if there is a problem with the generator overload	0 ~ 99 sec (0 – No alarms)	3
11	At what frequency “ Hertz ” will generator operate?	0 → 60 Hz 1 → 50 Hz	0
12	Test for Over-speed?	0 → No 1 → Yes	1
13	Test Over-speed using the generator output or Magnetic Pick-Up	0 → Generator 1 → Magnetic Pick-Up	0
14	Over-speed shutdown setting	1 → 105% 2 → 110% 3 → 115% 4 → 120%	4
15	Time before Generator STOPs, if there is a problem with generator frequency output	0 ~ 60 sec	5
16	Time to set Pre-Heat of engine	0 ~ 30 sec (0 – No Pre-Heat)	10
17	Number of start attempts	1 ~ 9	3
18	Time to run the engine starter with each engine start.	2 ~ 30 sec	6
19	Remove starter by using the Magnetic Pick-up?	0 → No 1 → Yes	0
20	Remove starter by using engine oil pressure sensor?	0 → No 1 → Yes	0
21	Low oil pressure switch Normally Open (NO) or normally close (NC)	0 → NO 1 → NC	1
22	Time before Generator STOPs, if there is a problem with low oil pressure	0 ~ 60 sec (0 – No alarms)	10
23	Time to Energize to STOP the fuel solenoid	2 ~ 60 sec	15
24	Is the STOP fuel Solenoid : Energize to STOP or Energize to START	0 → Energize to STOP 1 → Energize to START	1

ITEM	DESCRIPTION	SETTING	FACTORY SETTING
25	Time for engine cool-down without load	0 ~ 60 min	0
26	If a load contactor is used, time allowed for engine warm-up before connecting the LOAD	0 ~ 99 sec	0
27	Temperature switch Normally Open (NO) or normally closed (NC)	0 → NO 1 → NC	0
28	Time before Generator STOPs, if there is a problem with engine temperature	0 ~ 60 sec (0 – No alarms)	5
29	Enable or disable the alarm output (pin 24)	0 → Disable 1 → Enable	0
30	Emergency STOP button Normally Open (NO) or normally closed (NC)	0 → NO 1 → NC	1
31	Overload sensor Normally Open (NO) or normally closed (NC)	0 → NO 1 → NC	0
32	Low fuel sensor Normally Open (NO) or normally closed (NC)	0 → NO 1 → NC	0
33	Low Engine fuel	0 → Warning 1 → Stop	0
34	Alarm 1 Normally Open (NO) or normally closed (NC)	0 → NO 1 → NC	0
35	Alarm 1 input	0 → Warning 1 → Stop	0
36	Time delay when alarm 1 input (Refer to chapter 3.8)	0 ~ 99 sec. (0 – No alarms)	0
37	Alarm 2 Normally Open (NO) or normally closed (NC)	0 → NO 1 → NC	0
38	Alarm 2 input	0 → Warning 1 → Stop	0
39	Alarm 3 Normally Open (NO) or normally closed (NC)	0 → NO 1 → NC	0
40	Alarm 3 input	0 → Warning 1 → Stop	0
41	Alarm 4 Normally Open (NO) or normally closed (NC)	0 → NO 1 → NC	0
42	Alarm 4 input	0 → Warning 1 → Stop	0
43	Engine service interval reminder (Refer to chapter 3.9)	0 ~ 99 (0 ~ 990 H) (0 –No maintenance)	0
44	Display mode setting (Refer to chapter 3.10)	0 → Fix 1 → Rotation	1
45	Is the generator working in TOOL mode? Warning : No Safety shutdowns on TOOL Mode Also LED Lamp Test (Refer to chapter 3.11)	0 → NO say Normal 1 → YES, Tool Mode	0

4. PROTECTIONS AND ALARMS

4.1 Information On The Display

The ECU-02 has a 4 digit display easily visible digital display. The 4 digit display indicates:

- Generator output voltage on each phase with the ± buttons
- Generator output current on each phase with the ± buttons
- Frequency
- Total running hour “Service”
- Battery voltage
- Programming parameter
- Fault alarms
- Timer count downs

Using with the Up (+) / DOWN (-) buttons you may select VOLT, AMP, FREQ, HOUR and Battery Voltage on the front display screen. To observe individual Voltage and Amperage on each phase, press UP (+) button. On a single phase system, the UP (+) key has no function.

NOTE

Set system phase setting in line 1 correctly. If set incorrectly, the ECU-02 will read the wrong voltage values.

4.2 Alarms

Alarms are non-critical warning conditions and do not affect the operation of the generator system. They serve to draw the operator’s attention to an undesirable condition. The warning alarm will reset automatically after the problem is fixed.

4.3 Engine Stop / Shutdowns

Engine STOPS/SHUTDOWNs are latching, or final. To restart the engine, the alarm must be accepted and cleared. Turn the Selector Switch to OFF position to RESET.

After fixing the fault indicated (See Table 4.4 below), restart the generator and resume normal operation.

4.4 Alarms Table

SYMBOL	DISCRIPTION	LEVEL
AL 00	Engine Start Failure	
AL 01	Over Speed	Shut Down
AL 02	Magnetic Pick-Up Defective	Shut Down
AL 03	Wrong Voltage	Shut Down
AL 04	Low Engine Oil Pressure	Shut Down
AL 05	Emergency STOP Pushed	Shut Down
AL 06	High Engine Temperature	Shut Down
AL 07	Generator Over Loaded	Shut Down
AL 08	Low Fuel	Shut Down or Warning
AL 09	Option 1	Shut Down or Warning
AL 10	Option 2	Shut Down or Warning
AL 11	Option 3	Shut Down or Warning
AL 12	Option 4	Shut Down or Warning
AL 13	Low Battery Voltage	Warning

5. INSTALLATION INSTRUCTIONS

The model ECU-02 Module has been designed for front panel mounting. Affixing the ECU-02 to the front panel is accomplished by 2 spring loaded clips located on each side of the module.

In conditions of excessive vibration the module should be mounted on suitable anti-vibration mountings.

5.1 Cooling

The module has been designed to operate over a wide temperature range, from -25 to +55°C. Nevertheless, allowances should be made for temperature increases within the control panel enclosure. Care should be taken **NOT** to mount possible heat sources near the module (i.e., battery chargers), unless adequate ventilation is provided. The relative humidity inside the control panel enclosure should not exceed 85%.

5.2 Panel Cut-Out (All Dimensions In mm.)

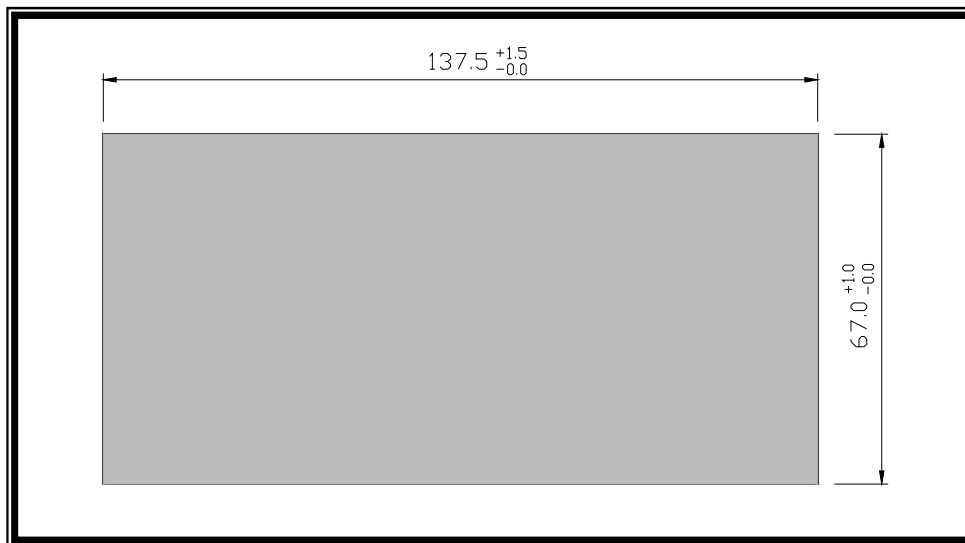

5.3 Unit Dimensions (All Dimensions In mm.)

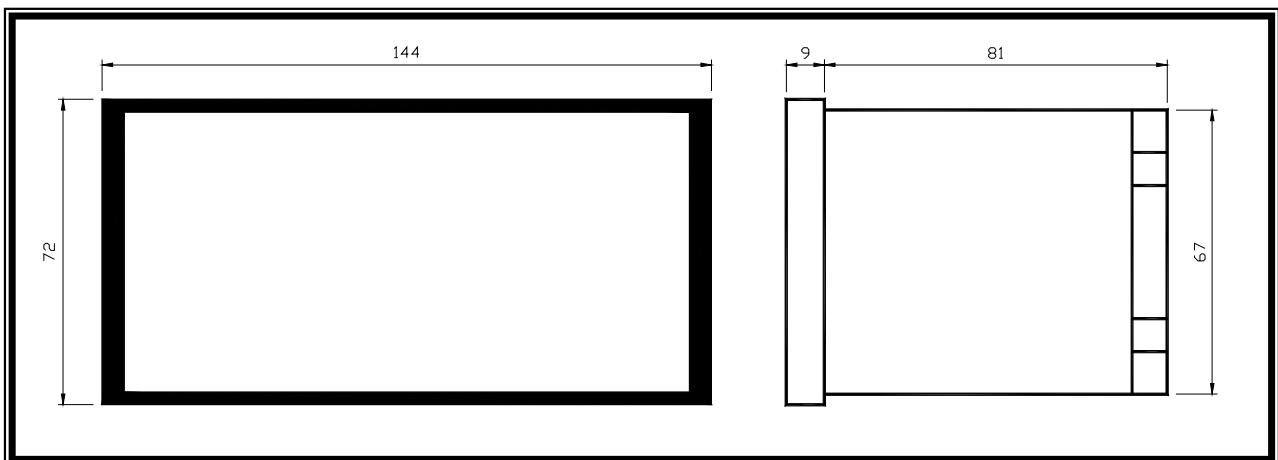

6. ELECTRICAL CONNECTIONS

6.1 Connection Details On The ECU-02

PLUG “ J1 ” 18 WAY

PIN No.	DESCRIPTION	NOTES
1	Not Used	Spare
2	Not Used	Spare
3	Generator L3 sensing input.	Connect to alternator L3 output.
4	Not Used	Spare
5	Generator L2 sensing input.	Connect to alternator L2 output.
6	Not Used	Spare
7	Generator L1 sensing input.	Connect to alternator L1 output.
8	Not Used	Spare
9	CT secondary for L3	Connect to secondary of L3 monitoring CT.
10	CT secondary for L3	Connect to secondary of L3 monitoring CT
11	CT secondary for L2	Connect to secondary of L2 monitoring CT
12	CT secondary for L2	Connect to secondary of L2 monitoring CT
13	CT secondary for L1	Connect to secondary of L1 monitoring CT
14	CT secondary for L1	Connect to secondary of L1 monitoring CT
15	Remote start input	Connect to A.T.S device
16	Remote start input	Connect to A.T.S device
17	DC Plant Supply Input (-v)	System DC negative input. (Battery Negative).
18	DC Plant Supply Input (+v)	System DC positive input. (Battery Positive). Recommended fuse 2 Amp

PLUG “ J2 ” 18 WAY

PIN No.	DESCRIPTION	NOTES
19	Warm up signal Output	Used to control the Warm UP contactor. Supply (-v) 2.5 Amp rated
20	Fuel solenoid signal Output	Used to control the fuel solenoid or engine fuel control system. Supply (-v) 2.5 Amp rated
21	Start signal Output	Used to control the Starter Motor. Supply (-v) 2.5 Amp rated
22	Auxiliary signal Output	Energize to start. Supply (-v) 2.5 Amp rated
23	Pre-heat signal Output	Used to control the internal Heater Supply (-v) 2.5 Amp rated
24	Alarm signal Output	Used to control external alarm buzzer. Supply (-v) 2.5 Amp rated
25	Emergency Stop Input	Connect to external emergency stop switch
26	Oil Pressure Input	Connect to Oil pressure sender
27	Coolant Temperature Input	Connect to Coolant Temperature sender
28	Overload sender Input	Connect to Overload sender
29	Low fuel sender Input	Connect to fuel sender
30	Auxiliary Input 1	This is a negative switched configurable input
31	Auxiliary Input 2	This is a negative switched configurable input
32	Auxiliary Input 3	This is a negative switched configurable input
33	Auxiliary Input 4	This is a negative switched configurable input
34	Not Used	Spare
35	Magnetic Pick-Up Input (+v)	Connect to Magnetic Pick-Up device. AC signal from the magnetic pickup for speed sensing
36	Magnetic Pick-Up Input (-v)	Connect to Magnetic Pick-Up device. AC signal from the magnetic pickup for speed sensing

6-2 Specification

DC Supply	9.0 to 30 V Continuous.
Alternator Input Range	15V - 380 (ph-ph) 3 Phase 3wire AC (+15%)
Alternator Input Frequency	50 ~ 60 Hz at rated engine speed
Magnetic Input Range (if fitted)	+/- 2V to 70V Peak
Magnetic Input Frequency	10,000 Hz (max) at rated engine speed
Warm up Signal Output	5 Amp DC at supply voltage
Fuel solenoid Signal Output	5 Amp DC at supply voltage
Start Signal Output	5 Amp DC at supply voltage
Pre-heat Signal Output	5 Amp DC at supply voltage
Auxiliary Signal Output	5 Amp DC at supply voltage
Alarm Signal Output	5 Amp DC at supply voltage
Operating Temperature Range	-25 to +55 °C
CT Burden	2.5VA
CT Secondary	5A

7. FAULT FINDING

SYMPTOM	POSSIBLE REMEDY
ECU-02 is inoperative	Check if the emergency stop is push on. Check the battery and wiring to the unit. Check Battery Volts on cranking. (not below 6V) Check the DC fuse F5 and F6.
Engine Shuts Down	Check DC supply voltage is not below 6 Volts. Check that operating temperature is not above 55 °C.
Engine locks out on Emergency Stop	If the Emergency Stop Button is not used, program line 24 to NO =0 Check emergency stop switch is functioning correctly. Check Wiring is not open circuit. Check line 24 setting is correct.
Intermittent Magnetic Pick-up sensor engine shutdown	Check magnetic pick-up is functioning correctly. Check Wiring is not open circuit. Check output voltage is not below less de 8 Volts RMS.
Low Oil Pressure shutdown after engine has started	Check engine oil pressure. Check oil pressure switch / sender and wiring. Check configured polarity is correct (i.e. NO or NC)
High engine temperature shutdown after engine has started	Check engine temperature. Check switch / sender and wiring. Check configured polarity is correct (i.e. NO or NC)
Shutdown occurs	Check switch and wiring of fault indicated on display. Check configuration of input.
Alarm occurs	Check relevant switch and wiring of fault indicated on display. Check configuration of input.
Engine fail to Start despite pre-set number of attempts	Check fuel. Check wiring of fuel solenoid. Check battery supply. Check the speed sensing signal is present on the inputs.
Continuous starting of generator when in AUTO	Check that the " Remote Start " input is not shorted.
Generator fails to start on receipt of Remote Start signal.	Check if engine Start Delay timer has timed out. If remote start faults, check if signal is on " Remote Start " input.
Pre-heat inoperative	Check wiring to engine heater plugs. Check that pre-heat has been selected in your program.
Starter motor inoperative	Check wiring to starter solenoid. Check starter motor. You have a 30 Amp limit.
Engine runs but generator will not take load	Check if warm up timer has timed out. Check warm up has been selected in your configuration.

8. TYPICAL WIRING DIAGRAM

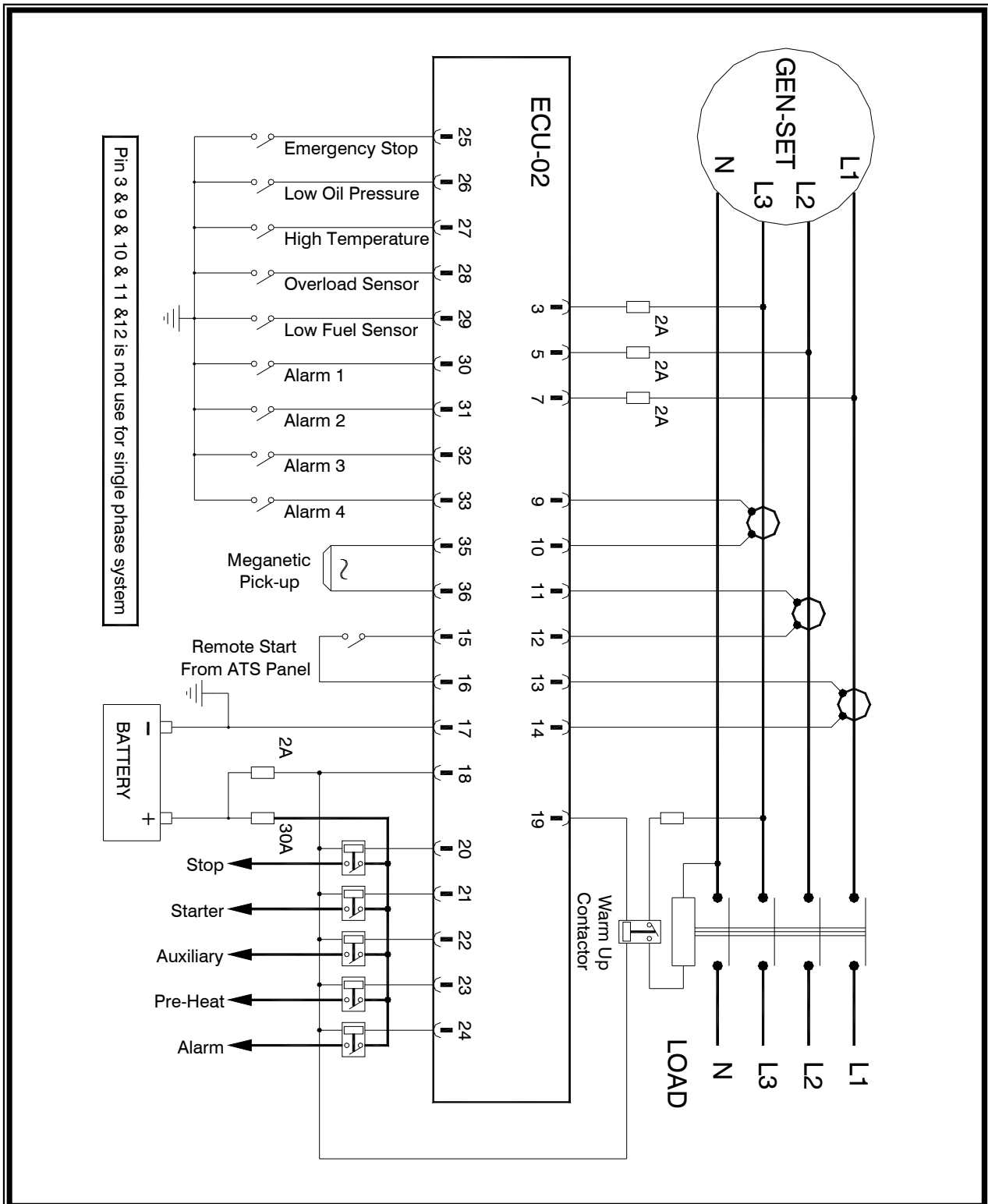

ECU-11(12V) & ECU-22(24V)

*Relay Module And Harness
For Quick Installation of ECU*

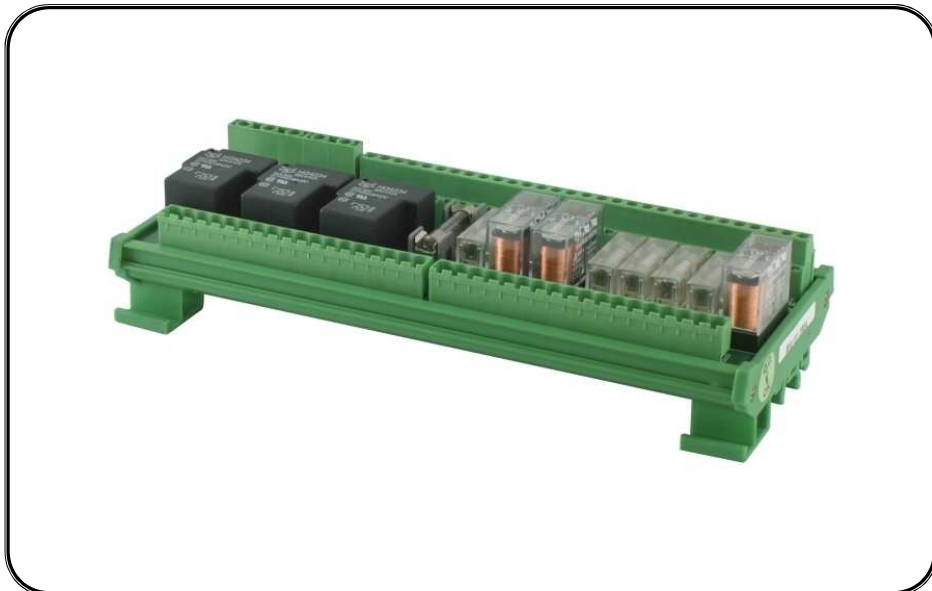

固也泰電子工業有限公司
KUTAI ELECTRONICS CO., LTD.



Headquarters : No.3, Lane 201, Chien Fu ST., Chyan Jenn Dist., Kaohsiung, TAIWAN

Tel : + 886-7-8121771

Fax : + 886-7-8121775

URL : <http://www.kutai.com.tw>

ECU-11 (12V) & ECU-22 (24V) RELAY MODULE OPERATORS MANUAL

1. Introduction

The Relay Module is the interface between the automatic engine control module ECU-02 and the generator. The ECU-11 & ECU-22 provides two 18 ways plugs to connect to ECU-02 module. All the protected fuses and power relays for engine

pre-heat, start, fuel, stop, and alarm output are pre-assembled on the relay module. Simply connect the control wires to the correct terminals on the module, thus minimizing assembly time and potential for errors when assembling and installing the engine control wires.

2. ECU-11(12V) & ECU-22(24V) Connection Details

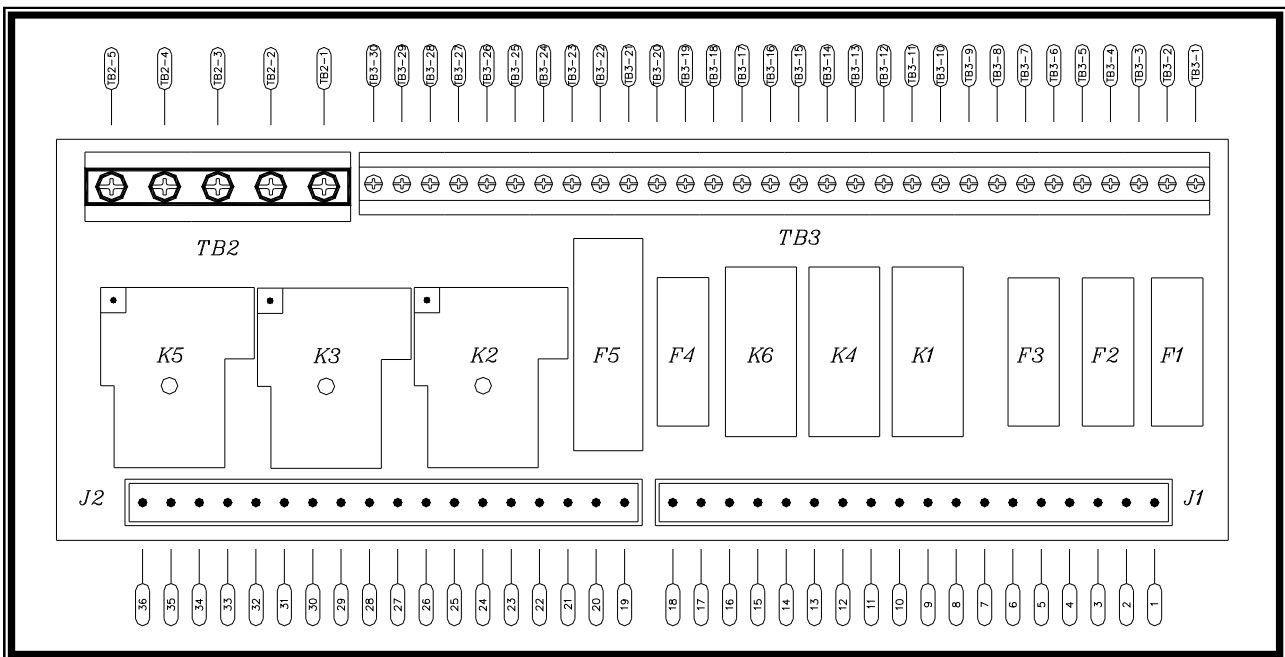

1. The plug J1 (Pin1 ~ Pin18) connected to the plug J1 of ECU-02.
2. The plug J2 (Pin19 ~ Pin36) connected to the plug J2 of ECU-02.

2.1 Terminal TB2 Power And 30 Amp Output Connections

PIN NO.	DESCRIPTION	NOTES
TB2-1	DC Plant Supply Input (-v)	System DC negative input. (Battery Negative). AWG10
TB2-2	DC Plant Supply Input (+v)	System DC positive input. (Battery Positive). AWG10
TB2-3	Fuel solenoid signal output Programmable to ET STOP or ET START	Controls the fuel solenoid or engine fuel control system. Supply (+v) 30 Amp rated.
TB2-4	Start signal output	Controls the Starter Motor. Supply (+v) 30 Amp rated.
TB2-5	Pre-heat signal output	Controls the engine pre heater Supply (+v) 30 Amp rated.

2.2 Terminal TB3

PIN NO.	DESCRIPTION	NOTES
TB3-1	Generator L3 sensing input	Connect to alternator L3 output.
TB3-2	Not Used	Spare.
TB3-3	Generator L2 sensing input	Connect to alternator L2 output.
TB3-4	Not Used	Spare.
TB3-5	Generator L1 sensing input	Connect to alternator L1 output.
TB3-6	Not Used	Spare.
TB3-7	Warm up signal Output	Used to control the Warm up contactor. 5 Amp rated.
TB3-8	Warm up signal Output	Used to control the Warm up contactor. 5 Amp rated.
TB3-9	CT secondary for L3	Connect to secondary of L3 monitoring CT.
TB3-10	CT secondary for L3	Connect to secondary of L3 monitoring CT.
TB3-11	CT secondary for L2	Connect to secondary of L2 monitoring CT.
TB3-12	CT secondary for L2	Connect to secondary of L2 monitoring CT.
TB3-13	CT secondary for L1	Connect to secondary of L1 monitoring CT.
TB3-14	CT secondary for L1	Connect to secondary of L1 monitoring CT.
TB3-15	Remote start input	Connect to A.T.S remote start contact.
TB3-16	Remote start input	Connect to A.T.S remote start contact.
TB3-17	Auxiliary signal Output	Energize to start. (+v) 5 Amp rated. (Not Programmable) for use with Electronic Governors, Battery charging alternator exciter. Etc.
TB3-18	Alarm signal Output	For use with an external alarm. Supply (+v) 5 Amp rated.
TB3-19	Emergency Stop Input	Connect to external emergency stop switch. (Panic Button)
TB3-20	Oil Pressure Input	Connect to Oil pressure sender.
TB3-21	Coolant Temperature Input	Connect to Coolant Temperature sender.
TB3-22	Overload sender Input	Connect to Overload sender.
TB3-23	Low fuel sender Input	Connect to low fuel indicator switch sensor.
TB3-24	Auxiliary Input 1	This is a negative switched configurable input with time out.
TB3-25	Auxiliary Input 2	This is a negative switched configurable input.
TB3-26	Auxiliary Input 3	This is a negative switched configurable input.
TB3-27	Auxiliary Input 4	This is a negative switched configurable input.
TB3-28	Not Used	Spare.
TB3-29	Magnetic Pick-up Input (+v)	Connect to Magnetic Pickup device. AC signal from the magnetic pick-up for speed sensing.
TB3-30	Magnetic Pick-up Input (-v)	Connect to Magnetic Pickup device. AC signal from the magnetic pick-up for speed sensing.

3. ECU-11(12V) & ECU-22(24V) Typical Wiring Diagram

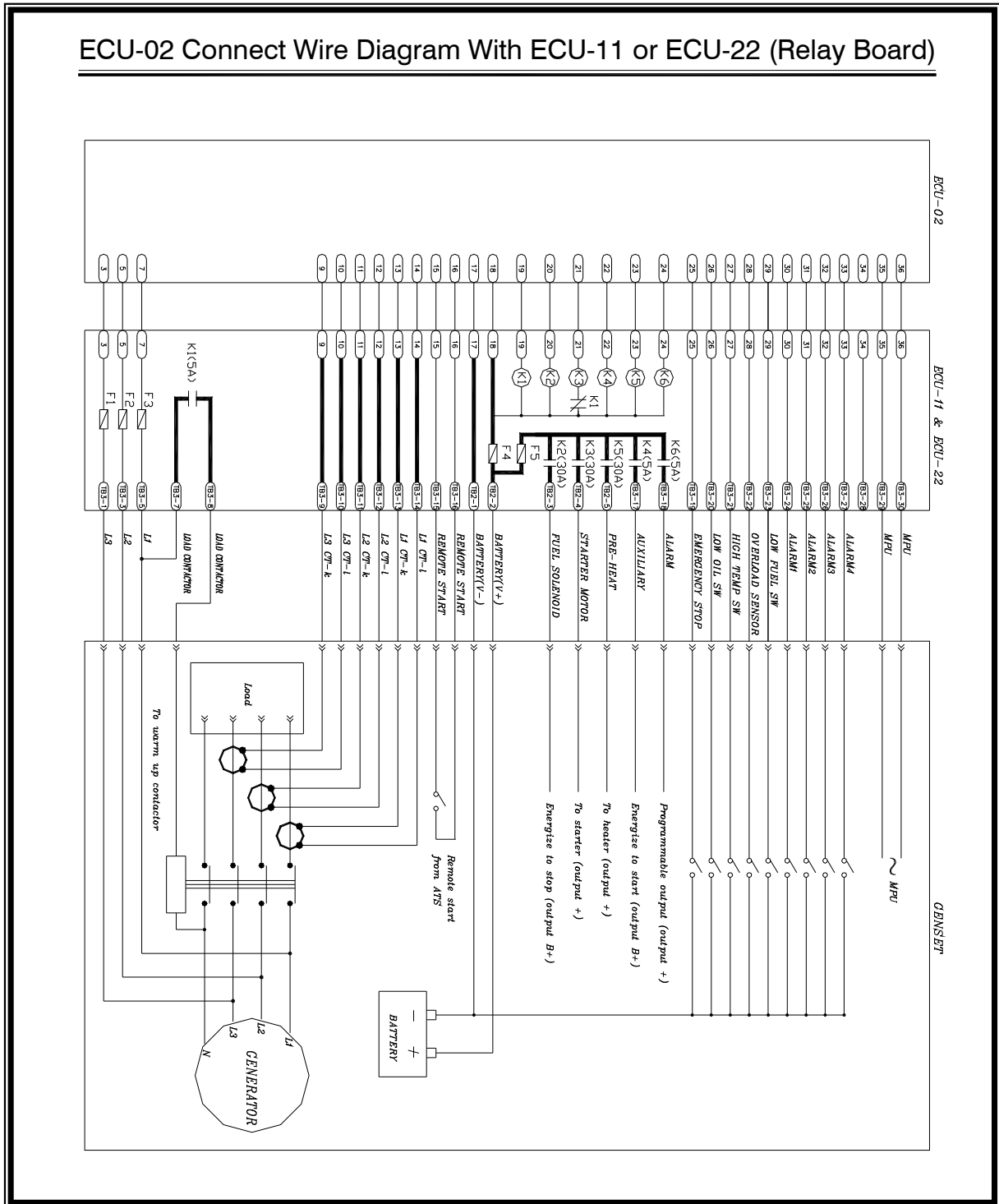

PTU-03

*Transformer Unit : PTU-03
ECU Voltage Isolation*



固也泰電子工業有限公司
KUTAI ELECTRONICS CO., LTD.



Headquarters : No.3, Lane 201, Chien Fu ST., Chyan Jenn Dist., Kaohsiung, TAIWAN

Tel : + 886-7-8121771

Fax : + 886-7-8121775

URL : <http://www.kutai.com.tw>

TRANSFORMER UNIT : PTU-03 (OPTION)

TRANSFORMER UNIT: PTU-03

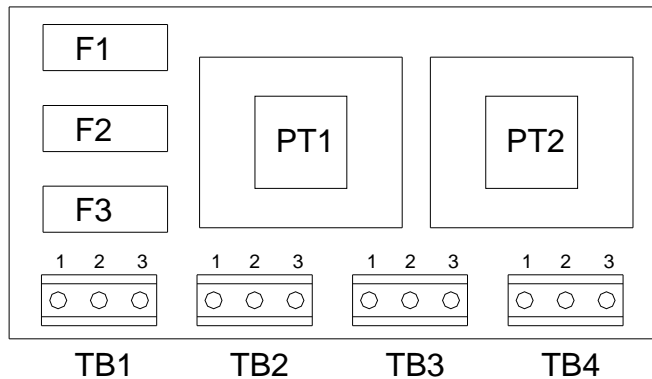

Pin NO.	Status	Rated(Max)	Volt Ratio
TB1	Input	600VAC	1
TB2	Output		1
TB3	Output		0.583
TB4	Output		0.5

Working with 208 ~ 240 volts generator
 PS : Set the programming line 38 to "0"

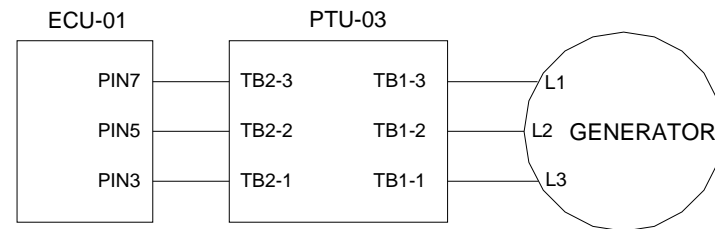

Working with 380 ~ 480 volts generator
 PS : Set the programming line 38 to "1"

